

Description

The HTU7G06S005P is an unmatched discrete LDMOS Power Amplifier with 5W saturated output power covering frequency range for VHF/UHF applications.

Features

- Operating Frequency Range: VHF/UHF
- Operating Drain Voltage: +3.6 to 7.5V
- Saturation Output Power: 4.5 to 10W
- Excellent thermal stability due to low thermal resistance package
- Enhanced robustness design without device degradation
- Internally integrated enhanced ESD design

Freq (MHz)	Vdd (V)	Pin (W)	Pout (W)	Eff (%)
400-470	3.6	0.50	4.5	60
400-470	7.2	0.32	8.0	65
400-470	7.5	0.32	10.0	63
136-174	4.0	0.50	5.0	68

Test conditions unless otherwise noted: 25 °C, CW Signal

Applications

- VHF Band handheld Walkie-talkie
- UHF Band handheld Walkie-talkie
- 1.8-600 MHz other application Drivers or Final stage Amplifiers

10-DFN (5x5 mm)

OUTLINE DRAWING **Mark: HTU7G06S005P**

Terminal No.
1: Gate
2: Source
3: Drain
UNIT: mm

Note: Exposed backside of the package is the source terminal for the transistor

Pin Connections

Ordering Information

Part Number	Description
HTU7G06S005P	Reel Package
HTU7G06S005P EVB	470 - 700 MHz EVB
HTU7G06S005P EVB1	136 - 174 MHz EVB

Absolute Maximum Ratings

Parameter	Range/Value	Unit
Drain voltage (V_{DSS})	-0.5, +26	V
Gate voltage (V_{GS})	-5 to +10	V
Operation voltage (V_{DD})	+0 to +9	V
Storage Temperature (T_{STG})	-55 to +150	°C
Junction Temperature (T_J)	-40 to +150	°C
Thermal Resistance Junction to Case (R_{TH})	2.8	°C/W

Electrical Specification

DC Characteristics

Parameter	Conditions	Min	Typ	Max	Unit
Breakdown Voltage $V_{(BR)DSS}$	$V_{gs}=0V, I_{ds}=500\mu A$	26	-	-	V
Gate-Source Threshold Voltage $V_{GS(th)}$	$V_{ds}=V_{gs}, I_{ds}=40\mu A$	1.2	1.5	1.8	V
Drain Leakage Current I_{DSS}	$V_{gs}=0V, V_{ds}=5V$	-	-	1	μA
Gate Leakage Current I_{GSS}	$V_{gs}=5V, V_{ds}=0V$	-	-	1	μA

Load Mismatch Test

Condition	Test Result
VSWR=20:1, at all Phase Angles, $V_{DD} = +7.2V_{dc}$, $I_{DQ} = 500mA$, CW signal 40dBm @435MHz test on WATECH Application Board	No Device Degradation
VSWR=20:1, at all Phase Angles, $V_{DD} = +9.5V_{dc}$, $I_{DQ} = 500mA$, CW signal 38.5dBm @435 MHz test on WATECH Application Board	No Device Degradation

RF Characteristics (CW)

Freq (MHz)	Vdd (V)@ I_{dq} (mA)	Pin (W)	Pout (W)	Eff (%)
155	4@600	0.5	5.0	68
435	4@600	0.5	5.0	65

Test conditions unless otherwise noted: 25 °C, CW Signal test on WATECH Application Board

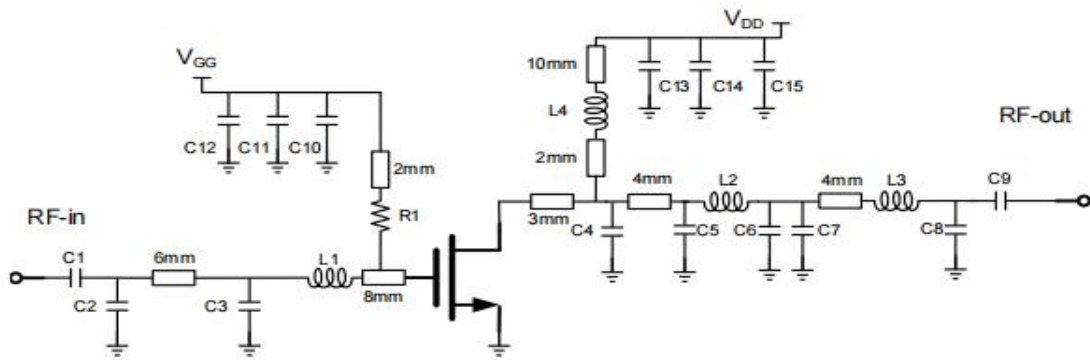
HTU7G06S005P 136- 174 MHz Reference Design (VHF)@4V

EVB Layout

BoM - HTU7G06S005P 136- 174 MHz Reference Design (VHF)@4V

Reference	Value	Description	Manufacturer	P/N
Q1	-	10W, 100 - 600 MHz LDMOS PA	Watech	HTU7G06S005P
C1, C4, C9, C10, C13	100pF	MLCC	Murata	GRM1885C1H101JA01
C2, C3	22pF	MLCC	Murata	GRM1885C1H220JA01
C5	82pF	MLCC	Murata	GRM1885C1H820JA01
C6	68pF	MLCC	Murata	GRM1885C1H680JA01
C7	12pF	MLCC	Murata	GRM1885C1H120JA01
C8	18pF	MLCC	Murata	GRM1885C1H180JA01
C11, C14	1nF	MLCC	Murata	GRM1885C1H102JA01
C12	4.7uF	MLCC	Murata	GRM32ER61H474KA12L
C15	10uF	MLCC	Murata	GRM32ER61H105KA12L
L1	18nH/0603		-	-
L2	D: 0.35mm, Inside: 1.0mm, 2 Turns		-	Enameled wire
L3	D: 0.4mm, Inside: 1.5mm, 3 Turns		-	Enameled wire
L4	D: 0.31mm, Inside: 1.5mm, 9 Turns		-	Enameled wire
R1	51Ω	Thick Film Resistor	YAGEO	RC0603FR-0751RL
PCB	FR-4 (er = 4.3), 30 mil (0.762 mm), 35 μm (1oz)			

Performance Plots 136- 174 MHz Reference Design (VHF)@4V

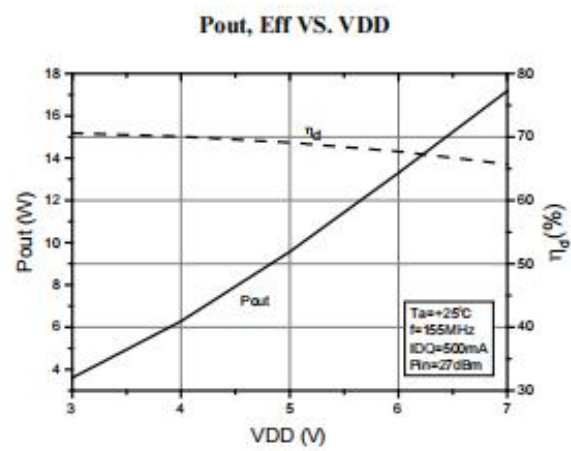
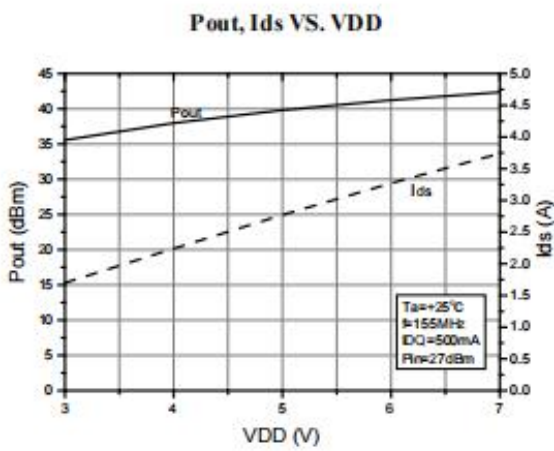
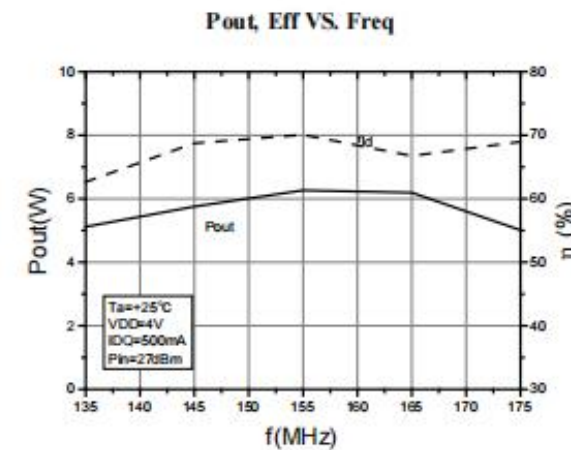
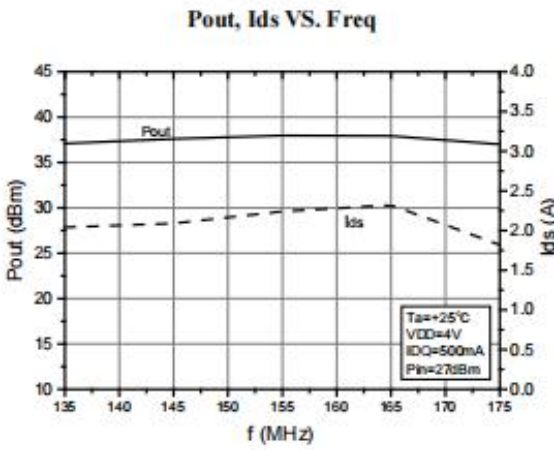
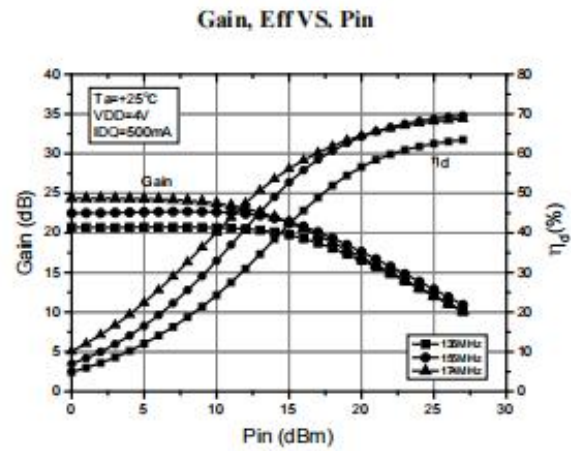
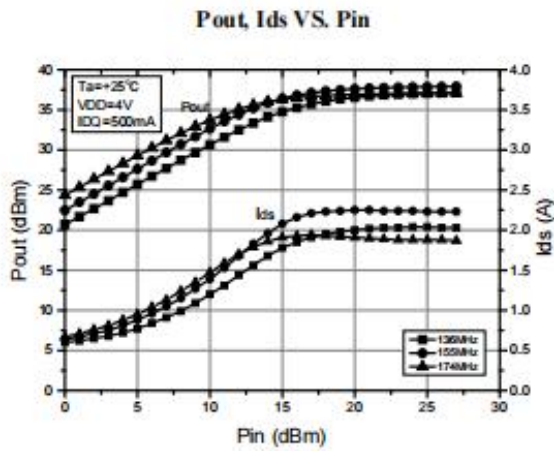

Test conditions unless otherwise noted: 25 °C, VDD = +4Vdc, IDQ=500mA, CW test on WATECH Application Board

HTU7G06S005P 400 - 470 MHz Reference Design (UHF)@3.6V

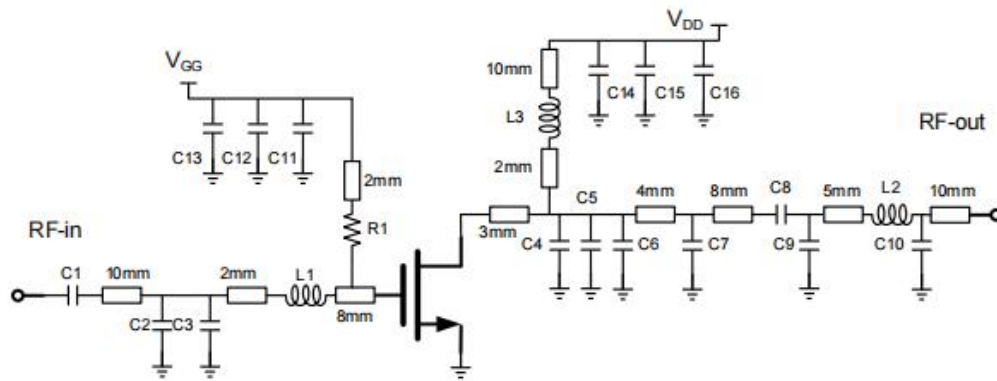

EVB Layout

BoM - HTU7G06S005P 400 - 470 MHz Reference Design (UHF)@3.6V

Reference	Value	Description	Manufacturer	P/N
Q1	-	10W, 100 - 600 MHz LDMOS PA	Watech	HTU7G06S005P
C1, C8, C11, C14	100pF	MLCC	Murata	GRM1885C1H101JA01
C2, C9	10pF	MLCC	Murata	GRM1885C1H100JA01
C3	15pF	MLCC	Murata	GRM1885C1H150JA01
C4, C5, C6	22pF	MLCC	Murata	GRM1885C1H220JA01
C7	27pF	MLCC	Murata	GRM1885C1H270JA01
C10	8pF	MLCC	Murata	GRM1885C1H8R0JA01
C12, C15	1nF	MLCC	Murata	GRM1885C1H102JA01
C13	4.7uF	MLCC	Murata	GRM32ER61H474KA12L
C16	10uF	MLCC	Murata	GRM32ER61H105KA12L
L1	3.3nH/0603		-	-
L2	D: 0.45mm, Inside: 1.8mm, 1.5 Turns		-	Enameled wire
L3	D: 1.0mm, Inside: 2.0mm, 5 Turns		-	Enameled wire
R1	51Ω	Thick Film Resistor	YAGEO	RC0603FR-0751RL
PCB	FR-4 (er = 4.3), 30 mil (0.762 mm), 35 μm (1oz)			

Performance Plots 400 - 470 MHz Reference Design (UHF)@3.6V

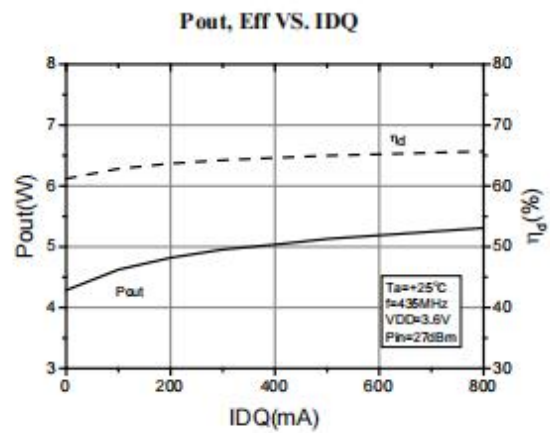
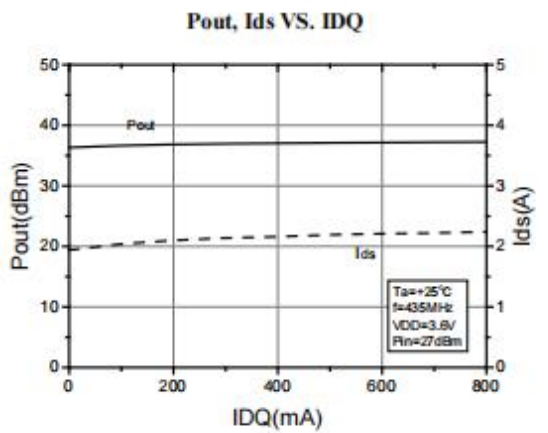
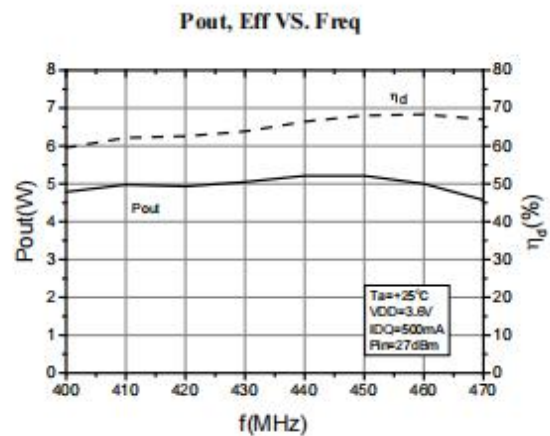
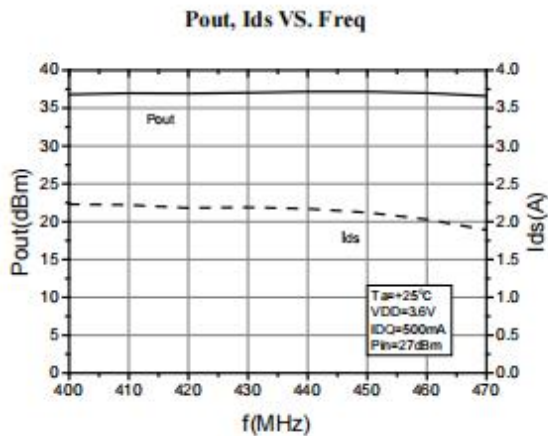
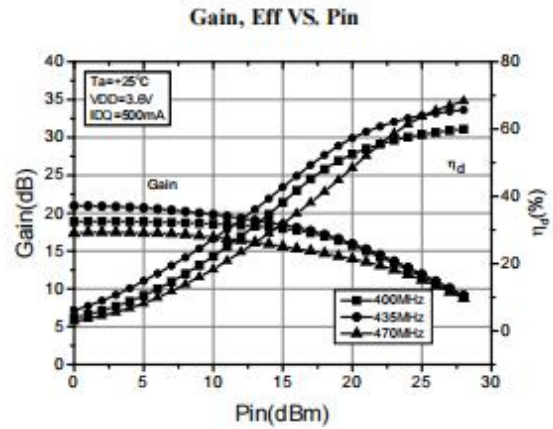
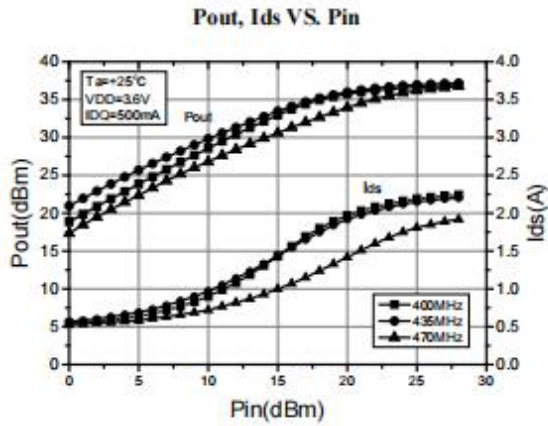

Test conditions unless otherwise noted: 25 °C, VDD = +3.6Vdc, IDQ=500mA, CW test on WATECH Application Board

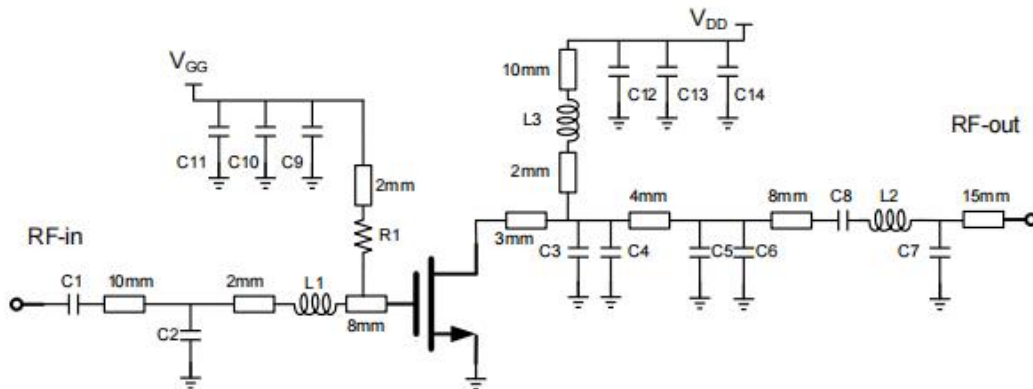
HTU7G06S005P 400 - 470 MHz Reference Design (UHF)@7.2V

EVB Layout
BoM - HTU7G06S005P Push-Pull 400 - 470 MHz Reference Design@7.2V

Reference	Value	Description	Manufacturer	P/N
Q1	-	10W, 100 - 600 MHz LDMOS PA	Watech	HTU7G06S005P
C1, C8, C11, C12	100pF	MLCC	Murata	GRM1885C1H101JA01
C2, C6	18pF	MLCC	Murata	GRM1885C1H180JA01
C3	22pF	MLCC	Murata	GRM1885C1H220JA01
C4	15pF	MLCC	Murata	GRM1885C1H150JA01
C5	2pF	MLCC	Murata	GRM1885C1H2R0JA01
C7	10pF	MLCC	Murata	GRM1885C1H100JA01
C10, c13	1nF	MLCC	Murata	GRM1885C1H102JA01
C11	4.7uF	MLCC	Murata	GRM32ER61H474KA12L
C14	10uF	MLCC	Murata	GRM32ER61H105KA12L
L1	3.3nH/0603		-	
L2	D: 0.31mm, Inside: 2.0mm, 1.5 Turns		-	Enameled wire
L3	D: 1.0mm, Inside: 2.0mm, 5 Turns		-	Enameled wire
R1	51Ω	Thick Film Resistor	YAGEO	RC0603FR-0751RL
PCB	FR-4 (er = 4.3), 30 mil (0.762 mm), 35 μm (1oz)			

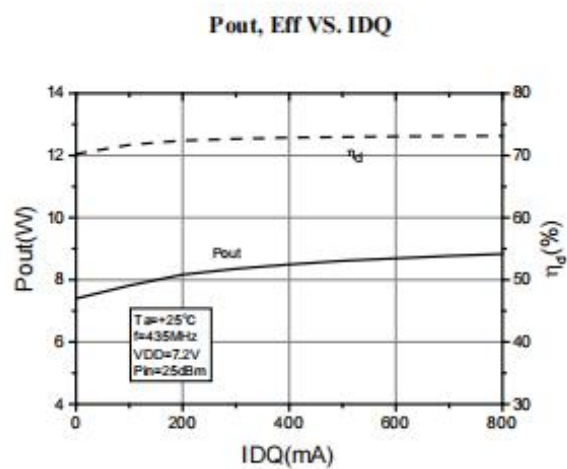
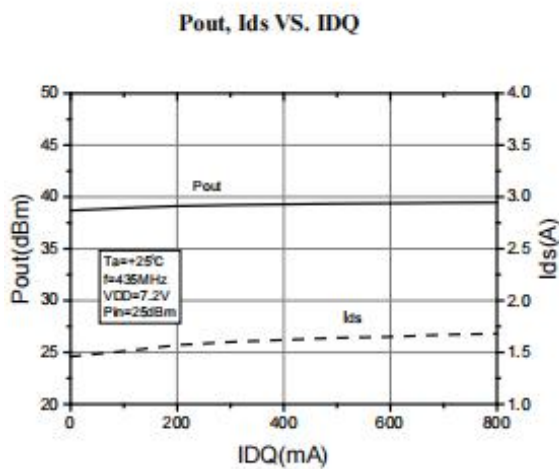
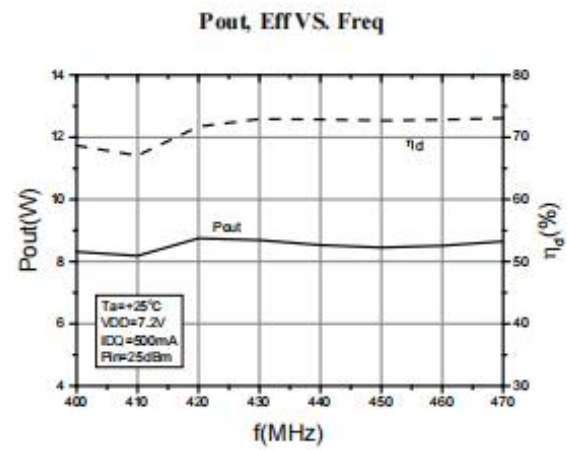
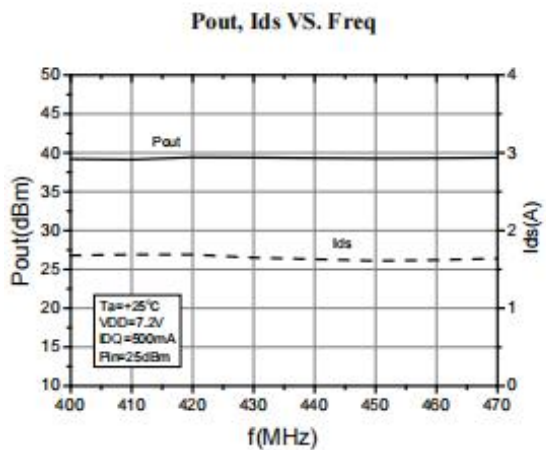
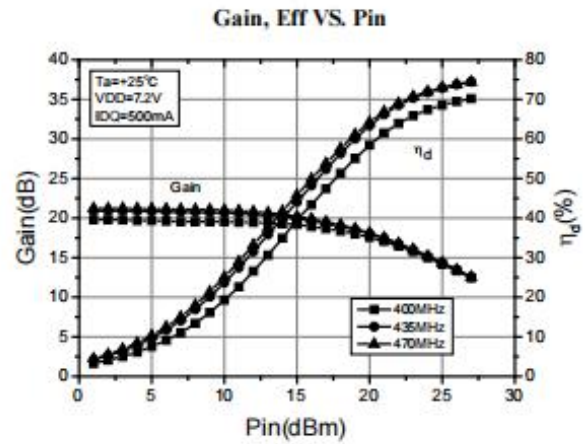
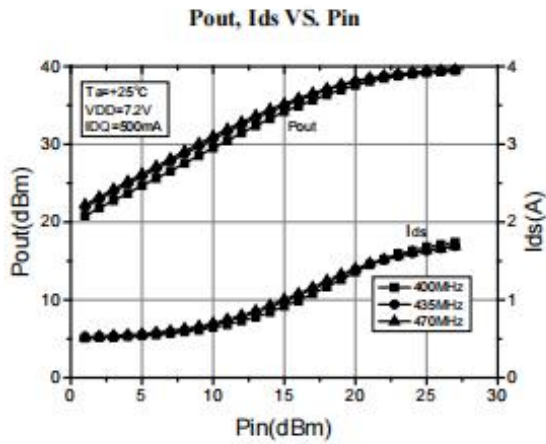
Performance Plots Push-Pull 400 - 470 MHz Reference Design (UHF)@7.2V

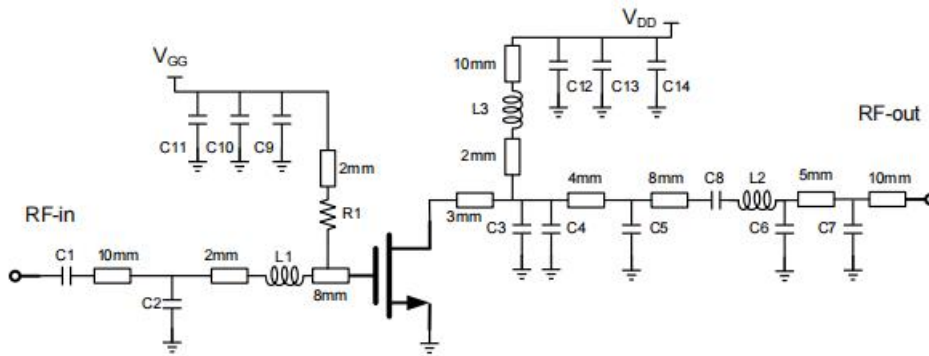

Test conditions unless otherwise noted: 25°C , $V_{DD} = +7.2\text{Vdc}$, $I_{DQ} = 500\text{mA}$, CW test on WATECH Application Board

HTU7G06S005P 400 - 470 MHz Reference Design (UHF)@7.5V

EVB Layout

BoM - HTU7G06S005P 400 - 470 MHz Reference Design (UHF)@7.5V

Reference	Value	Description	Manufacturer	P/N
Q1	-	10W, 100 - 600 MHz LDMOS PA	Watech	HTU7G06S005P
C1, C8, C11, C12	100pF	MLCC	Murata	GRM1885C1H101JA01
C2	18pF	MLCC	Murata	GRM1885C1H180JA01
C3	22pF	MLCC	Murata	GRM1885C1H220JA01
C4, C5	15pF	MLCC	Murata	GRM1885C1H150JA01
C6	7pF	MLCC	Murata	GRM1885C1H7R0JA01
C7	1pF	MLCC	Murata	GRM1885C1H1R0JA01
C10, c13	1nF	MLCC	Murata	GRM1885C1H102JA01
C11	4.7uF	MLCC	Murata	GRM32ER61H474KA12L
C14	10uF	MLCC	Murata	GRM32ER61H105KA12L
L1	3.3nH/0603		-	
L2	D: 0.31mm, Inside: 2.0mm, 1.5 Turns		-	Enameled wire
L3	D: 1.0mm, Inside: 2.0mm, 5 Turns		-	Enameled wire
R1	51Ω	Thick Film Resistor	YAGEO	RC0603FR-0751RL
PCB	FR-4 (er = 4.3), 30 mil (0.762 mm), 35 μm (1oz)			

Performance Plots 400 - 470 MHz Reference Design (UHF)@7.5V

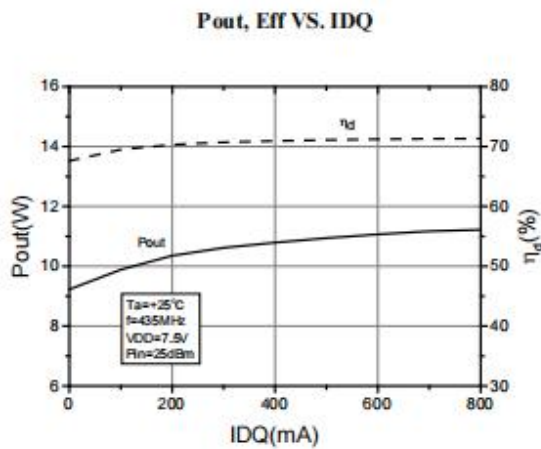
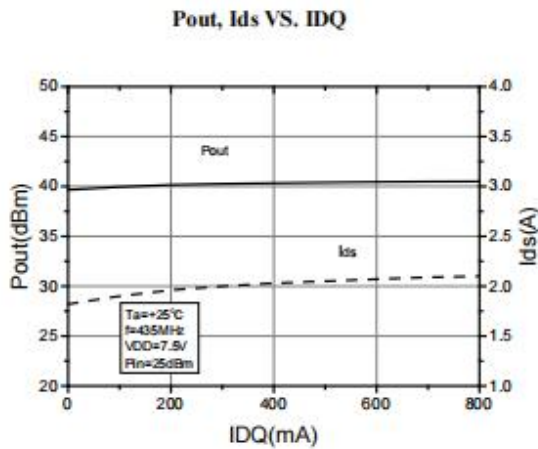
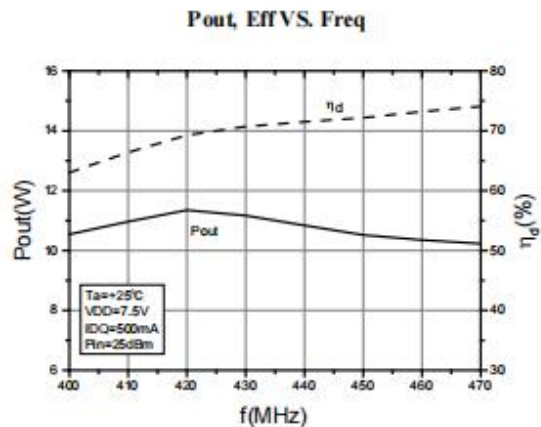
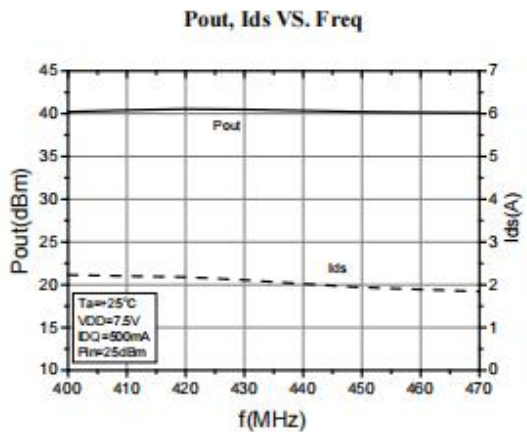
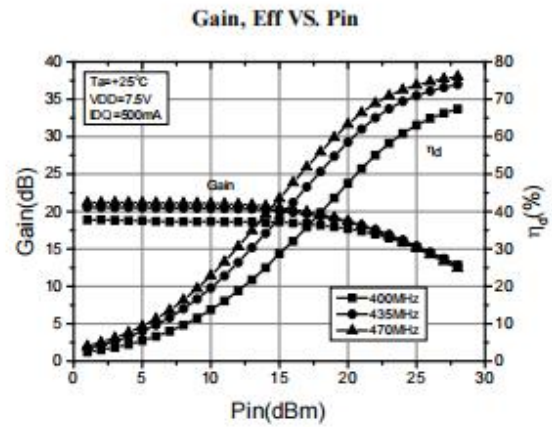
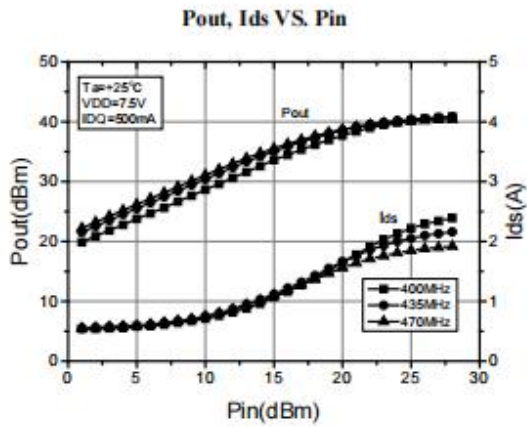

Test conditions unless otherwise noted: 25°C , $V_{DD} = +7.5\text{Vdc}$, $IDQ = 500\text{mA}$, CW test on WATECH Application Board

Package Marking and Dimensions



- Line1 (fixed): Device name in W/O
- Line2 (unfixed): Take the last 8 digits of Marking Lot No in W/O (Sample: E596-20140001, just take “20140001”)
- Line3 (unfixed): Date Code + JY
This Marking SPEC only stipulates the content of Marking. For marking requirements such as font and size, please refer to the latest version of “Watech Product Printing Specification”

Marking

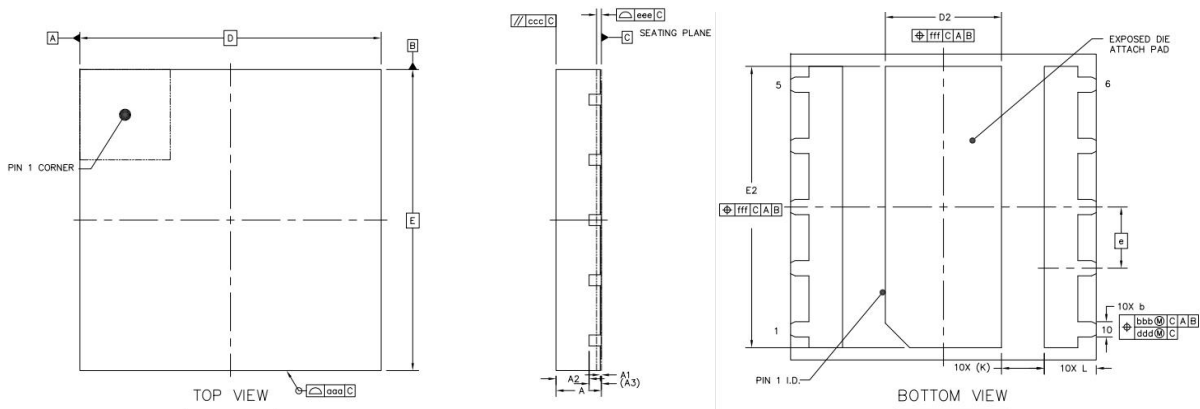

	SYMBOL	MIN	NOM	MAX	
TOTAL THICKNESS	A	0.8	0.85	0.9	
STAND OFF	A1	0	0.02	0.05	
MOLD THICKNESS	A2	---	0.65	---	
L/F THICKNESS	A3	0.203 REF			
LEAD WIDTH	b	0.2	0.25	0.3	
BODY SIZE	X	D	5 BSC		
	Y	E	5 BSC		
LEAD PITCH	e	1 BSC			
EP SIZE	X	D2	1.8	1.9	2
	Y	E2	4.5	4.6	4.7
LEAD LENGTH	L	0.75	0.85	0.95	
LEAD TIP TO EXPOSED PAD EDGE	K	0.7 REF			
PACKAGE EDGE TOLERANCE	aaa	0.1			
MOLD FLATNESS	ccc	0.1			
COPLANARITY	eee	0.08			
LEAD OFFSET	bbb	0.1			
	ddd	0.05			
EXPOSED PAD OFFSET	fff	0.1			

Package Dimensions

Tape and Reel Information

Package Type	Reel Size(inch)	Qty/Reel(pcs)	Qty/Box(pcs)	Qty/Carton(pcs)
DFN5*5	7inch	1000	8000	32000

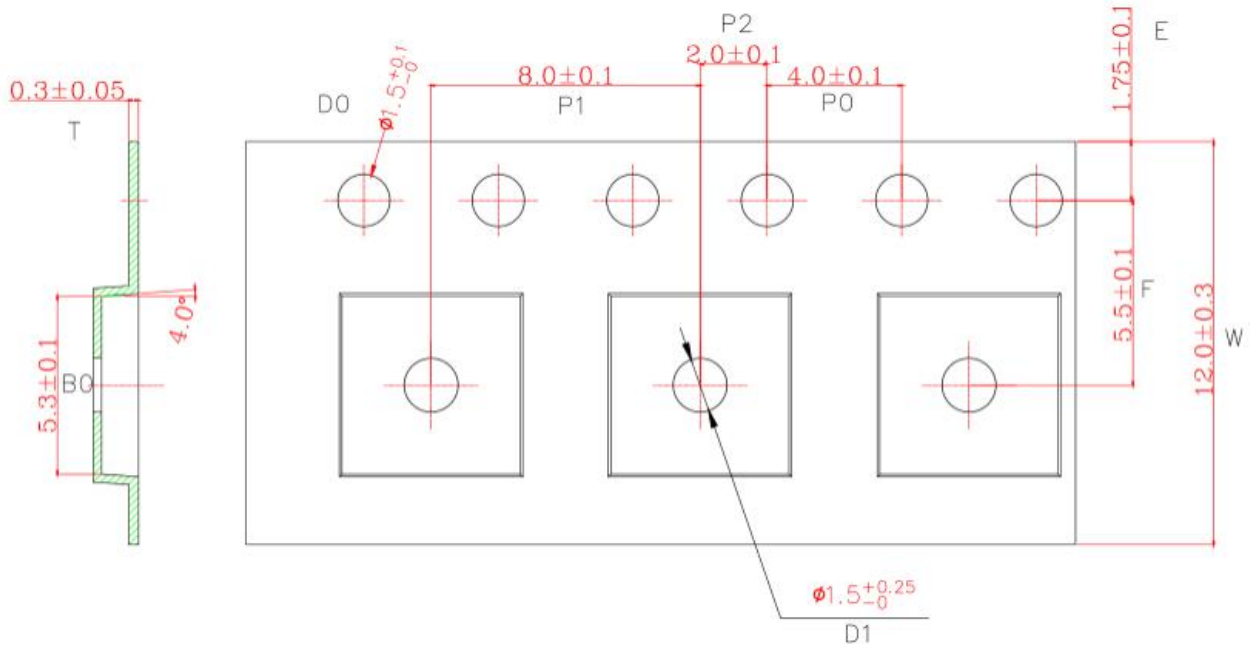

Tape & Reel Packaging Descriptions

Handling Precautions

Parameter	Rating	Standard
ESD – Human Body Model (HBM)	Class 1B	JESD22-A114
ESD – Human Body Model (MM)	Class A	EIA/JESD22-A115
ESD – Charged Device Model (CDM)	Class III	JESD22-C101

RoHS Compliance

This product is compliant with the 2011/65/EU RoHS directive (Restrictions on the Use of Certain Hazardous Substances in Electrical and Electronic Equipment), as amended by Directive 2015/863/EU.

Datasheet Status

Document status	Product status	Definition
Objective Datasheet	Design simulation	Product objective specification
Preliminary Datasheet	Customer sample	Engineering samples and first test results
Product Datasheet	Mass production	Final product specification

Abbreviations

Acronym	Definition
LDMOS	Laterally-Diffused Metal-Oxide Semiconductor
CW	Continuous Waveform

Revision history

Document ID	Datasheet Status	Release Date	Revision Version
Rev 2.7	Product	March 2023	New format based on English version datasheet
Rev 2.8	Product	March 2024	Version released after re review



HTU7G06S005P

10W, 1.8- 600 MHz LDMOS Amplifier

Product datasheet

Contact Information

For the latest specifications, additional product information, worldwide sales and distribution locations and information about WATECH:

- Web: www.watechelectronics.com
- Email: MKT@huatai-elec.com

For technical questions and application information:

- Email: MKT@huatai-elec.com

Important Notice

Information in this document is believed to be accurate and reliable. However, WATECH does not give any representations or warranties, expressed or implied, as to the accuracy or completeness of such information and shall have no liability for the consequences of use of such information.

“Typical” parameters are the average values expected by WATECH in large quantities and are provided for information purposes only. All information and specifications contained herein are subject to change without notice and customers should obtain and verify the latest relevant information before placing orders for WATECH products.

The information contained herein or any use of such information does not grant, explicitly or implicitly, to any party any patent rights, licenses, or any other intellectual property rights, whether with regard to such information itself or anything described by such information.

Applications that are described herein for any of these products are for illustrative purposes only. WATECH makes no representation or warranty that such applications will be suitable for the specified use without further testing or modification. Customers are responsible for the design and operation of their applications and products using WATECH products, and WATECH accepts no liability for any assistance with applications or customer product design. It is customer's sole responsibility to determine whether the WATECH product is suitable and fit for the customer's applications and products planned, as well as for the planned application and use of customer's third-party customer(s). Customers should provide appropriate design and operating safeguards to minimize the risks associated with their applications and products.

WATECH products are not designed, authorized or warranted to be suitable for use in life support, life-critical or safety- critical systems or equipment, nor in applications where failure or malfunction of a WATECH product can reasonably be expected to result in personal injury, death or severe property or environmental damage. This document as well as the item(s) described herein may be subject to export control regulations. Export might require a prior authorization from competent authorities.